



**HERCULUX**  
恒坤光电

Chengdu HercuLux Photoelectric  
Technology Co.,Ltd  
**Product Approval**

Approval number :

Effective date of approval :

Customer :

Product : HK 4 in 1 Road lam Lens ( 155X80 )

Material Code : 1.02.6877

PN : HK-50@09-155X80-5050-#0-0g-4

Manufacturer : Chengdu HercuLux Photoelectric Technology Co.,Ltd

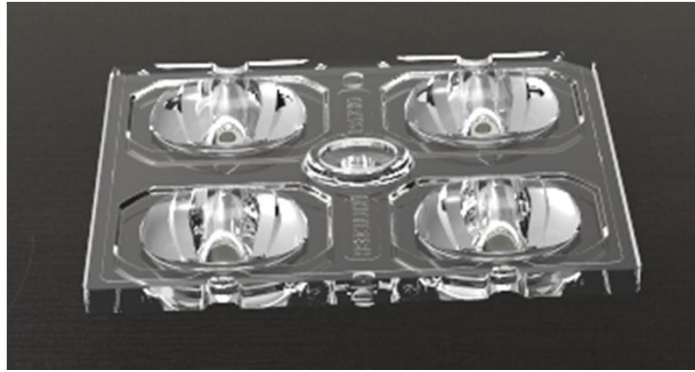

Supplier confirmation				Client confirmation			
Proposed		DATE		Qualified <input type="checkbox"/>		DATE	
Project manager		DATE		Unqualified <input type="checkbox"/>		DATE	
Audit		DATE		Audit		DATE	
Approved		DATE		Approved		DATE	
Stamp		DATE		Stamp		DATE	

( Confirmation of acceptance by both parties must be signed and sealed )

Factory: Chengdu Shuangliu District, Iot industrial park 2 road HercuLux Photoelectric Park

Phone : 028-85887727 ( 801 ) 028-85887990 ( 801 )

Fax : 028-85887730

www.hkoptics.com

Sales Dept: Shenzhen Nanshan District Nanshan Cloud Valley Innovation Industrial Park Comprehensive Service Building,

TEL: 0755-2937 1541

FAX: 0755-2907 5140

\*Approval In duplicate , for both supplier and customer.



**HERCULUX**  
恒坤光电

# Product Approval

TEL: 0755-2937 1541

FAX: 0755-2907 5140

www.hkoptics.com

Date updated: 2018/6/6

Product Picture:	
PN:	HK-50@09-155X80-5050-#0-0g-4
Size(L*W*H/ $\Phi$ *H):	$\Phi$ :50mm; H:6.1mm
Material:	PC
Effiency:	\
Temperature(Topr):	-40°C to +120°C
FWHM:	150°X90°
Matched LES:	LUXEON 5050

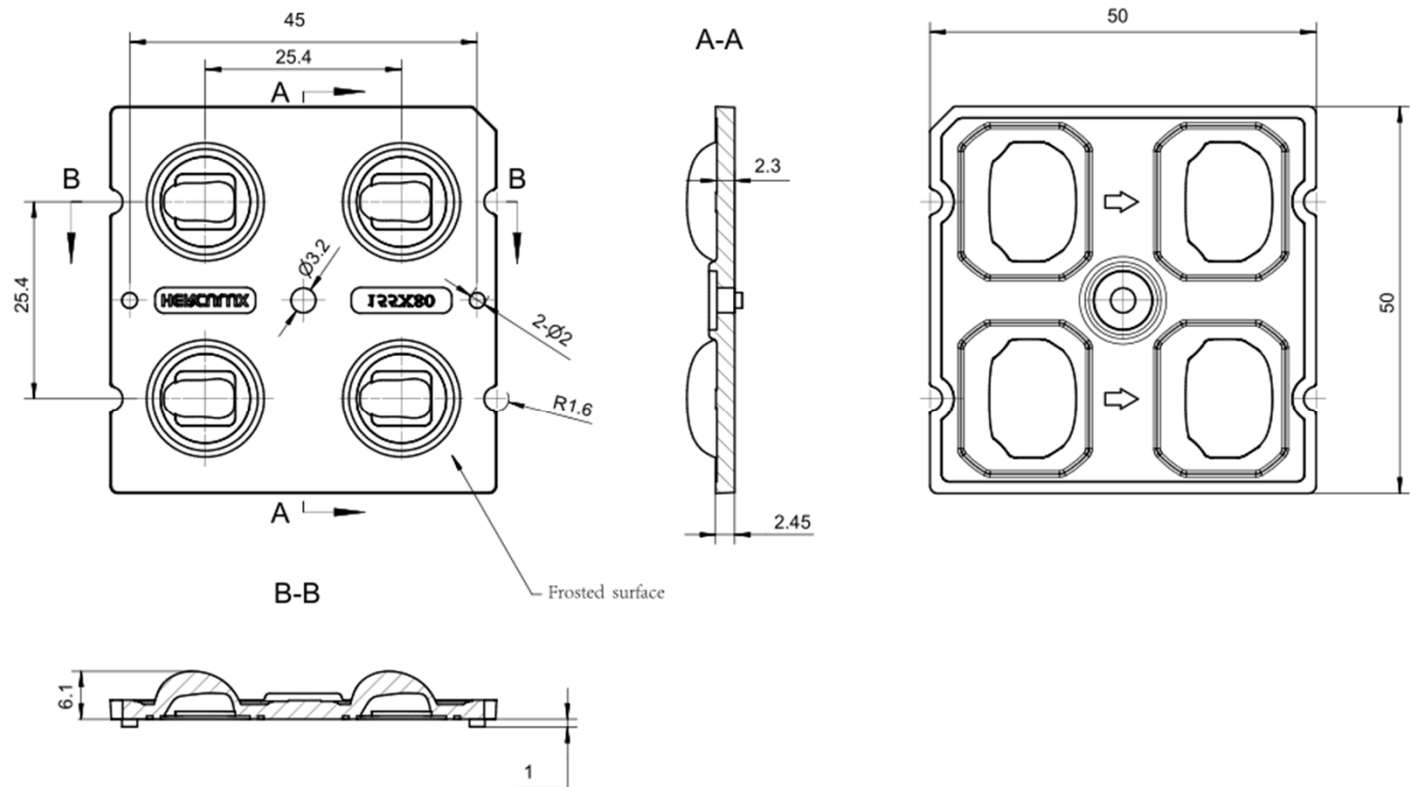

Technical Requirement:

1. The surface don't have any defects of flash, shrink and bubble.
2. The uncharted fillet and pattern draft subject to the 3D drawing.
3. The uncharted dimensional tolerance subject to the 3D drawing.

Optical Design		HK 4 in 1 Road lam Lens (155X80)	HK-50@09-155X80-5050-#0-0g-4		1. 02. 6877
Structure Design			Pages	Qty	Weight
Assess			2		
Authorized		Material:PC	CDHK		

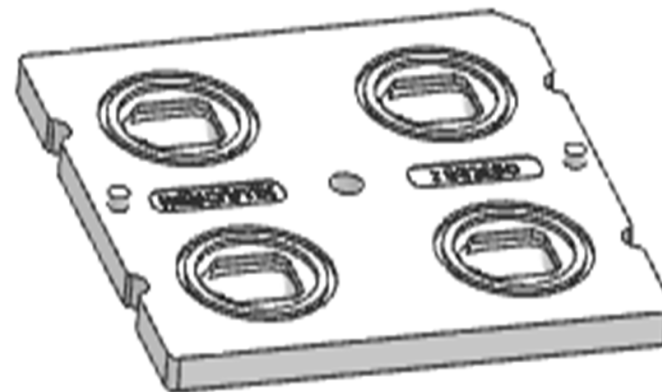
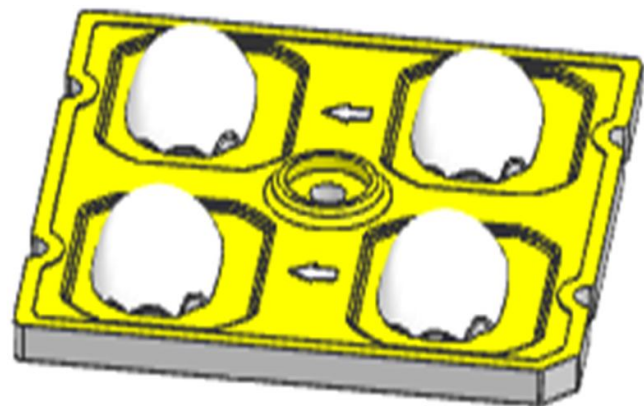

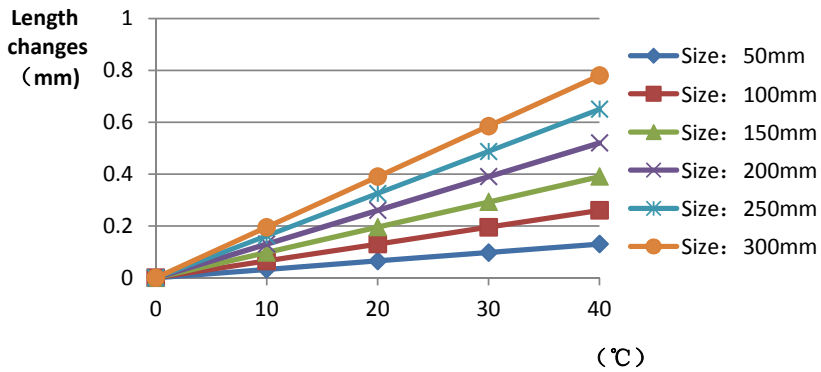

		Standard size	Upper Size limit	Lower size limit	Test result1	Test result2	Test result3	Judgment																																									
1.Size	OW	50	50.15	49.85	50.03	49.98	50.05	OK																																									
	S of locating	45	45.1	44.9	44.99	44.99	44.99	OK																																									
	D of locating	2	2.05	1.95	2	1.99	2	OK																																									
	TH	2.3	2.4	2.25	2.35	2.36	2.34	OK																																									
	Gate shear can not affect the appearance of the lamp																																																
See attachment "Appearance Inspection Standards"																																																	
2.Appearance Quality	See attachment "Appearance Inspection Standards"	E	No burr	No burr	No burr	No burr	OK																																										
			No stains	No stains	No stains	No burr																																											
3.Material	PC			Color	Transparent		OK																																										
4.Optical index	Testing LED	LUXEON 5050																																															
	FWHM	See light distribution curve																																															
	Angle			92.8° X155.4°	91.3° X153.7°	92.8° X155.4°	OK																																										
	Efficiency			98.00%																																													
	Facula	See the signature sample																																															
Comprehensive judgment	Qualified																																																
Remarks:	<p>1、 Tool Number: V-Vernier Caliper 2D-Quadratic H-Height Gauge M-Tool Microscope P-Needle T-Thick Gauge R-Radius Gauge E-Visual.</p> <p>2、 Test environment: In 20 °C -25 °C environment to achieve thermal equilibrium after the test. (Ambient temperature on the size of the product refer to the table on the right)</p>																																																
	<p align="center"><b>PC product size changes with temperature table</b></p>  <table border="1"> <caption>Data for PC product size changes with temperature table</caption> <thead> <tr> <th>Temperature (°C)</th> <th>50mm</th> <th>100mm</th> <th>150mm</th> <th>200mm</th> <th>250mm</th> <th>300mm</th> </tr> </thead> <tbody> <tr> <td>0</td> <td>0.00</td> <td>0.00</td> <td>0.00</td> <td>0.00</td> <td>0.00</td> <td>0.00</td> </tr> <tr> <td>10</td> <td>0.05</td> <td>0.08</td> <td>0.10</td> <td>0.12</td> <td>0.15</td> <td>0.20</td> </tr> <tr> <td>20</td> <td>0.10</td> <td>0.15</td> <td>0.20</td> <td>0.25</td> <td>0.30</td> <td>0.40</td> </tr> <tr> <td>30</td> <td>0.15</td> <td>0.20</td> <td>0.28</td> <td>0.35</td> <td>0.45</td> <td>0.60</td> </tr> <tr> <td>40</td> <td>0.20</td> <td>0.25</td> <td>0.35</td> <td>0.45</td> <td>0.65</td> <td>0.80</td> </tr> </tbody> </table>							Temperature (°C)	50mm	100mm	150mm	200mm	250mm	300mm	0	0.00	0.00	0.00	0.00	0.00	0.00	10	0.05	0.08	0.10	0.12	0.15	0.20	20	0.10	0.15	0.20	0.25	0.30	0.40	30	0.15	0.20	0.28	0.35	0.45	0.60	40	0.20	0.25	0.35	0.45	0.65	0.80
Temperature (°C)	50mm	100mm	150mm	200mm	250mm	300mm																																											
0	0.00	0.00	0.00	0.00	0.00	0.00																																											
10	0.05	0.08	0.10	0.12	0.15	0.20																																											
20	0.10	0.15	0.20	0.25	0.30	0.40																																											
30	0.15	0.20	0.28	0.35	0.45	0.60																																											
40	0.20	0.25	0.35	0.45	0.65	0.80																																											
Precautions:	<p>1、 Wear clean gloves during lens assembly to prevent contamination of the lens surface.</p> <p>2、 Take the lens try to avoid touching the total reflection surface.</p> <p>3、 When the lens surface contamination, you can only gently wipe with soft cotton sticky neat neutral solvent, not allowed to wipe with industrial solvents.</p>																																																

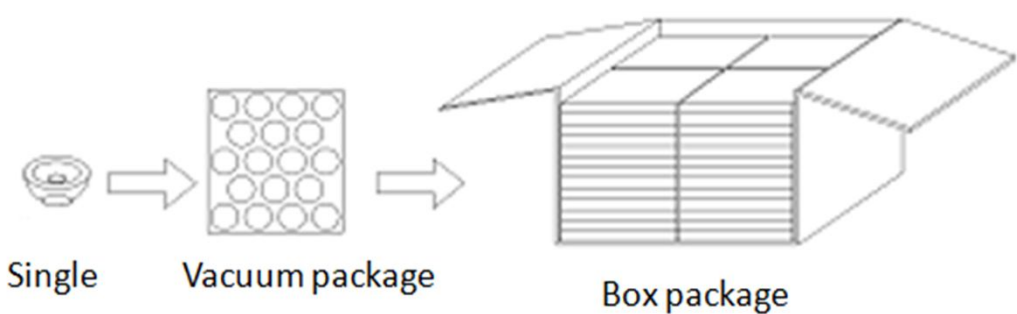
PN	HK-50@09-155X80-5050-#0-0g-4		Product Name	HK 4 in 1 Road lam Lens (155X80)			
Product material	PC		Customer				
Package diagram	 <p>Single → Vacuum package → Box package</p>						
Product packing	24	A/ Box	4	Box/Layer			
	15	Layer/Box	1440	A/ Carton			
Packaging Materials	NO.	Part No	Part name	Size	Dosage	Unit	Remarks
	1	2.07.0049	Blister box	23cm*21cm	60	BAG	
	2	2.08.0001	PE film	30cm*30cm	60	PCS	
	3	2.06.0005	Reel label paper	6.2cm*8cm	60	PCS	
	4	2.06.0005	Box label paper	6.2cm*9.2cm	1	PCS	
	5	2.06.0003	big plate	46.8cm*42.8cm	16	PCS	
	6	2.06.0001	big carton	46.8cm*42.8cm*36cm	1	PCS	
Remarks	Scattered packaging is not subject to this specification						



Special notice

When gule pass through holes, columns and other structures, or part of the thin structure, will form a weld line. The product which uses multi-point injection welding line will appear because of the combination of sol, as shown below:

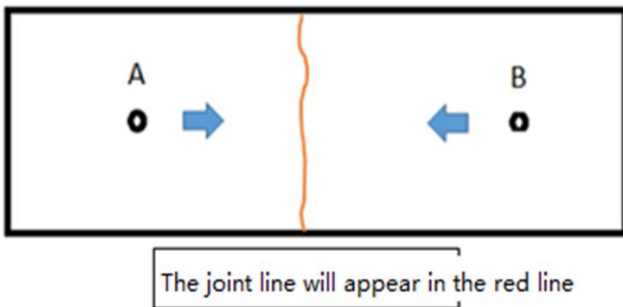
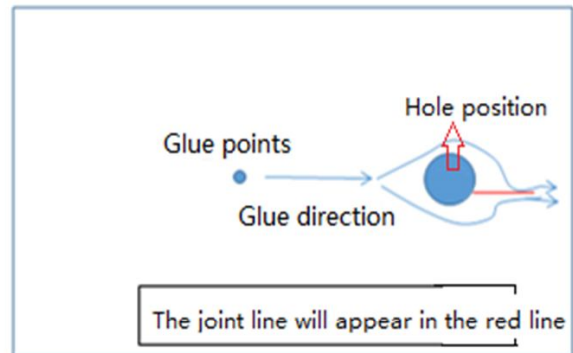
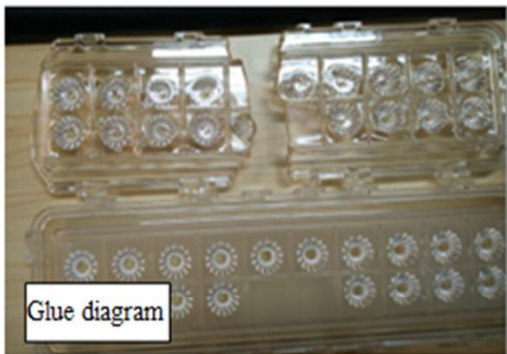
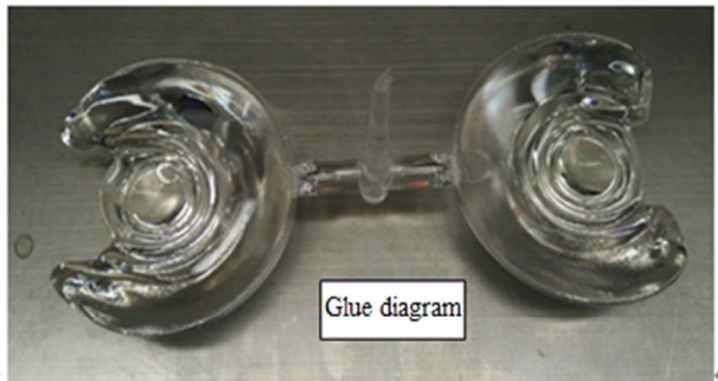
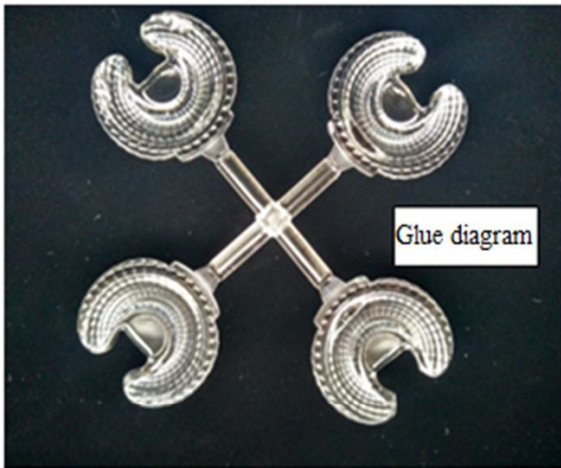

Please note :

The appearance of lines in the structure of the product as well as at the screw hole is a normal phenomenon, will not affect the actual use of the product, and can not be avoided at this stage.



## Appearance inspection standards

### 1 Operating procedures

#### 1.1.1 Sampling standards, sampling plan and AQL

Test level : GB/T2828.1-2012 The first part is according to the acceptance quality limit (AQL) retrieval batch inspection sampling plan, general inspection level II level, CR class defect coefficient 0, MA defect rejection level AQL = 0.65, MI class defect rejection level AQL = 1.0; defect level please see 5.4.

#### 2 Code table

Code	Code description	Unit	Code		Code description	Unit
N	Amount/pcs	pcs	D		Diameter	mm
L	Length	mm	H		Depth	mm
W	Width	mm	DS		Distance	mm
S	Proportion	mm <sup>2</sup>	SS		Offset	mm

### 3 Test conditions

3.1 Sight distance and working hours: Sight distance should be 30-35cm, each side of the inspection time does not exceed 12s, the visual angle of 45-135 degrees;

3.2 Light: 2x40w cool white fluorescent lamp, chip should be from the lens surface 500-550mm, in order to make the bad appearance can be correctly found, the illumination should not be less than 500Lux ;

3.3 Visual inspection staff should be 1.0 (including corrected visual acuity) above, no color blindness, color weakness.

### 4 Appearance inspection standards

Test items	Judging standard	Inspection equipment	Defect level		
		Testing method	MI	MA	CR
Check the sample	When start the machine and process, all products have to check the appearance of the sample, the appearance of the sample is divided into qualified samples and limited samples.	Sample comparison , visual			
	1: Qualified sample refers to the appearance and structure standard of the product which recognized by the client, the sample size should be confirmed before mass production;				

	2: The limited sample refers to the limit of a particular exceptionally developed sample. Limit the sample only for its specific point of exception to confirm; The priority is higher than the other criteria in this table. When there is a limited sample, the limit sample shall prevail.				
Raw edge	Not allowed to affect the size and assembly	Visual, point card		√	
Scratch	1: Non-optical surface and non-exposed surface scratches should be visually insignificant and the length is less than 1/10 of the maximum surface size.	Visual, point card, calipers		√	
Fingerprint	Fingerprints are not allowed on all products	Visual		√	
Foreign things, impurities	The product may not be attached to foreign objects, including oil, fiber, dregs of water gap and so on				√
Deformation	Insufficient filling shall not affect the appearance of the assembly and the exposed surfaces.	Visual, feeler			√
Poor ejection	Products may not appear bad ejection, including no convex top, thimble printed on the assembly surface shall not be higher than the product surface, non-assembled surface thimble height should not exceed the product size tolerances; thimble printing should be less than the product surface and no more than 0.3; thimble surface treatment should be consistent with the product side.	Visual, point card		√	
	Ejection strain: the optical surface and the appearance of the exposed surface after assembly are not allowed to have a strain, and the structural surface does not allow visual obvious strain.				
Insufficient filling	Insufficient filling shall not affect the appearance of the assembly and the exposed surfaces , The signature sample shall prevail.	Visual, point card		√	
Shrink	When the entire surface of the product shrinks, the optical properties and dimensions must meet the requirements, and the visual will not significantly affect the appearance.Part shrink reference point defects	Visual, point card		√	
Flow marks、Welding line	1 : Product does not allow the presence of flow marks and welding lines unless the structure can not be avoided;	Visual		√	
	2: The remaining flow marks shall not appear in the optical surface, a single L ≤ 10mm, no more than two				

Bubble	No bubbles are allowed	Visual		√	
Foreign matter、Dark spots	Not obvious or $D \leq 0.3\text{mm}$ black spots and foreign bodies in the area of 100x100mm not more than 1; Exceeded foreign matter black spots is judged bad.	Visual, point card	√		
Damaged	No damage is allowed	Visual			√
Cold glue	Optical surface may not have cold glue, non-optical surface cold glue should meet the visual is not obvious.	Visual	√		
Bad incision	1: Do not affect the product size, shall not penetrate the optical surface, the cut should be smooth;	Visual			√
	2: Laser cutting products, the optical surface burns shall not occur after the processing is completed. Beading must not affect product installation				
	3: Three molds and hot runner gate shall not appear residue.				
Scrub	Scrub surface should be uniform, off the scrub phenomenon should not be obvious , A single off scrub imprint requires $D \leq 1\text{ mm}$ and no more than 1 area within a 50x50 mm area	Visual		√	